

# ELECTRIC STEPPER PRODUCTS & PLANETARY GEARBOX

*APEX DYNAMICS*



**MOTORS  
DRIVES  
CONTROLS  
ACCESSORIES**



**CONTENTS**

Stepper Product Features .....MRS\_2  
 DS & SI Features .....MRS\_3  
 DS & SI Specification .....MRS\_5  
 Software .....MRS\_6  
 MRS Motor Dimensions .....MRS\_7  
 HUB Multi-Axis Motion .....MRS\_9  
 MMI Operator Interface ..... MRS\_11  
 BOB Breakout Board ..... MRS\_11  
 Stepper Prod. Ordering ..... MRS\_12

# Stepper Products

## OVERVIEW

## STEPPER PRODUCT FEATURES

### DRIVE **DS** **SI**

- Self Test  
*Measures motor parameters automatically to optimize system performance*
- Anti-resonance  
*Achieves higher speeds and better torque utilization*
- Command Signal Smoothing  
*Reduces extraneous system resonances*
- Torque Ripple Smoothing (Waveform Smoothing)  
*Adjusts current waveform to reduce low speed torque ripple*

### MOTORS **MRS**

- Speeds up to 3,000 RPM
- High resolution (up to 51,200 steps-rev)
- Holding torque requirements up to 1845 oz-in. (13.03 Nm)
- 2000 line Quadrature encoder option
- 10 ft. power cables with connector pre-wired

### MULTI-AXIS HUB WITH I/O **HUB**

- Networks stepper products for multi-axis motion applications
- For real-time execution of commands downloaded from a host PC or PLC using Si™ Command Language (SCL)
- Programmable for stand-alone single or multi-axis operations with Applied Motion's easy to use *SiNet Hub Programmer™* Windows software (software and programming cable included)

### OPERATOR INTERFACE **MMI**

- Flush or surface mounting
- Four line by 20 character LCD display
- RS232 communication to **SI** [STAC6-Si] controllers
- Enter distances, speeds, and repeat counts to pre-assigned variables in Si™ programming



## APPLICATION EXAMPLES

- Pick and place
- Inspection (camera positioning)
- Painting/stencilling
- Gating
- Parts transfer
- Positioning stops/guides
- Position tables
- Indexing
- Work piece placement

# Stepper Products

## DS & SI DRIVE FEATURES

The **DS** [STAC6-S] & **SI** [STAC6-SI] represent the latest developments in stepper drive technology, incorporating features that derive the highest performance from today's stepper motors. Anti-resonance and waveform damping control algorithms make them the clear market leader.

### ADVANCED FEATURES

- Self Test  
*Measures motor parameters automatically to optimize system performance*
- Anti-resonance  
*Achieves higher speeds and better torque utilization*
- Command Signal Smoothing  
*Reduces extraneous system resonances*
- Torque Ripple Smoothing (Waveform Smoothing)  
*Adjusts current waveform to reduce low speed torque ripple*
- Microstep Emulation  
*Smooth, high resolution motion in any application*

### FEATURES

- Current Output 0.5 to 6.0 A
- 90-135 VAC Input, 50/60 Hz  
(for other voltages, contact Tolomatic)
- 167V Bus
- Set-up and configuration software
- Configurable Idle current reduction
- External control options
- Pulse and Direction
- Analog Command Signal
- Host command via RS232/485.
- Integral control options -  
*Si Programmer™ - intuitive easy to use graphical programming language.*



**Basic drive;** analog, digital and host command input.

- Pulse & direction with microstep emulation
- A/B Quadrature pulse with electronic gearing
- CW and CCW pulse
- Multi-axis functionality if used with a **HUB** [SINet Hub]
- "Host" commands for real time control from a host PC or PLC using RS-232 or RS-485 serial communication.
- Velocity control mode with fixed rate, proportional analog, and joystick compatibility



**Controller/drive;** single axis indexer/drive.

- **SI** [STAC6-SI] can be programmed for stand-alone operation with the easy to use *Si Programmer™* Windows® software with integrated motor set-up (software and programming cable included).
- Graphical point and click format combines motion, I/O, and operator interface functionality for simple machine sequencing.
- **SI** [STAC6-SI] can be set-up for Q programming with register manipulation, conditional processing, math functions, and multi-tasking using a comprehensive programming language.



# Stepper Products

## **D****S** & **S****I** ADVANCED FEATURES

### MICROSTEP EMULATION

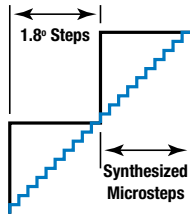

With Microstep Emulation, systems that have a need to use low step resolutions can still provide smooth motion. The drive takes the step count and creates microsteps which are fed to the motor.

As an example, this could be used on a retrofit system where the controller resolution is fixed at a low value and cannot easily be changed.

### COMMAND SIGNAL SMOOTHING

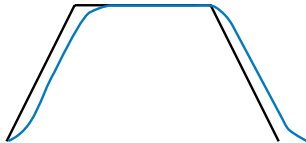

Dynamic smoothing can soften the effect of immediate changes in velocity and direction, making the motion of the motor less jerky. An added advantage is that this can reduce the wear on mechanical components.

### TORQUE RIPPLE SMOOTHING (WAVE FORM SMOOTHING)

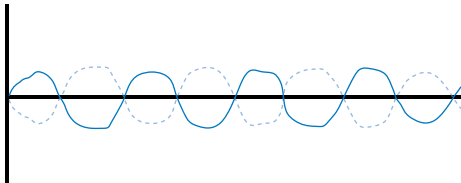

All step motors have an inherent low speed torque ripple that can effect the motion of the motor. By analyzing this torque ripple, the system can apply a negative harmonic to negate this effect. This gives the motor much smoother motion at low speed.

### ANTI-RESONANCE

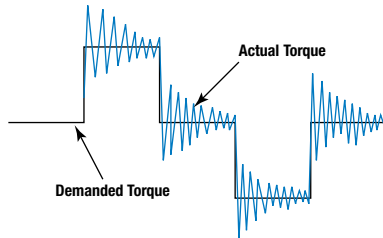

Step motors tend to “resonate” at some frequency. By entering system data, this natural frequency can be calculated and a damping term entered into the control algorithm. This significantly improves the midrange stability and allows the motor to achieve higher speeds and make more use of the available torque.

### SELF TEST



At start-up, the drive measures the motor parameters, including the resistance and inductance, then uses this information to optimize the system performance. It also compares this information from the last start-up and checks to see if the motor data has changed. This could indicate a fault or system change. The drive can also detect open and short circuits and incorrect motor wiring.

### ENCODER FEEDBACK FUNCTIONS



With the addition of an encoder on the motor the **D****S** [STAC6-S] & **S****I** [STAC6-Si] can provide additional functions.

- **Stall Detect** - The drive detects if the motor has stalled and triggers the fault output.
- **Stall Prevention** - Prevent motor stalls before they occur by allowing the drive to automatically reduce motor speed to optimize torque.

# Stepper Products

## **DS** & **SI** TECHNICAL SPECIFICATIONS

### POWER AMPLIFIER SPECIFICATIONS

AMPLIFIER TYPE	MOSFET, Dual H-Bridge, 4 Quadrant
CURRENT CONTROL	4 state PWM at 20 KHz
OUTPUT CURRENT	0.5— 6.0 in 0.01 amp increments
POWER SUPPLY	Line Operated Nominal 120 VAC, 50/60 Hz
DC BUS VOLTAGE	Nominal 165 VDC
AC INPUT VOLTAGE	90—135 VAC, 50/60 Hz (for other voltages, contact Tolomatic)
PROTECTION	Over-Voltage, Under voltage, Over-Temp, External Output Shorts (Phase-to-Phase, Phase-to-Ground), Internal Amplifier Shorts
IDLE CURRENT REDUCTION	Reduction to any integer percent of full-current after delay selectable in milliseconds.
MOTOR REGENERATION	Built in regeneration circuit - 50 watts max.

### CONTROLLER SPECIFICATIONS

NON-VOLATILE STORAGE	Configurations are saved in FLASH memory aboard the DSP
MODE OF OPERATION	Step & Direction, CW/CCW, A/B Quadrature pulse, stored program, Joystick
STEP AND DIRECTION INPUTS	Optically Isolated: 5 Volt. Minimum pulse width = 200 ns. Maximum pulse frequency = 2 MHz
SPEED RANGE	Depends upon application. Amplifier is suitable for speeds up to 133 rps
RESOLUTION	Software selectable from 200-to-51200 steps/rev in increments of 2 steps/rev
ANTI RESONANCE	Raises the system damping ratio to eliminate midrange instability allowing stable operation to 50 rps or greater
TORQUE SMOOTHING	Allows for fine adjustment of phase current waveform harmonic content to reduce low-speed torque ripple in the range 0.25 — 1.5 rps
AUTO SETUP	Measures motor parameters automatically
SELF TEST	Identifies the presence of an encoder and determines resolution. Diagnoses miswires and open phases
MICROSTEP EMULATION	Performs low resolution stepping by synthesizing fine microsteps from coarse steps
ENCODER OPTION	Employs encoder to provide failsafe stall detect
INTERFACE	RS-232 and RS-485 Bus
ENCODER	Differential line receivers suitable for 200 KHz or greater
AMBIENT TEMPERATURE	32- 158° F (0 to 70° C)
HUMIDITY	90% non-condensing

### FEATURES SUMMARY

		<b>DS</b> [STAC6-S]	<b>SI</b> [STAC6-SI]
Hub		✓	✓
Command Inputs	Pulse and Direction	✓	✓
	CW and CCW Pulse	✓	✓
	Master Encoder	✓	✓
Command Modes	Host Command Language	✓	✓
	Si Indexer		✓
Logic Input Functions	Enable	✓	✓
	Limit Switches	✓	✓
	Alarm Reset	✓	✓
Logic Output Functions	Alarm	✓	✓
	Brake	✓	✓
	Motion	✓	✓
Analog Inputs		✓	
Digital Inputs		7	15
Digital Outputs		3	7

### DIMENSIONS

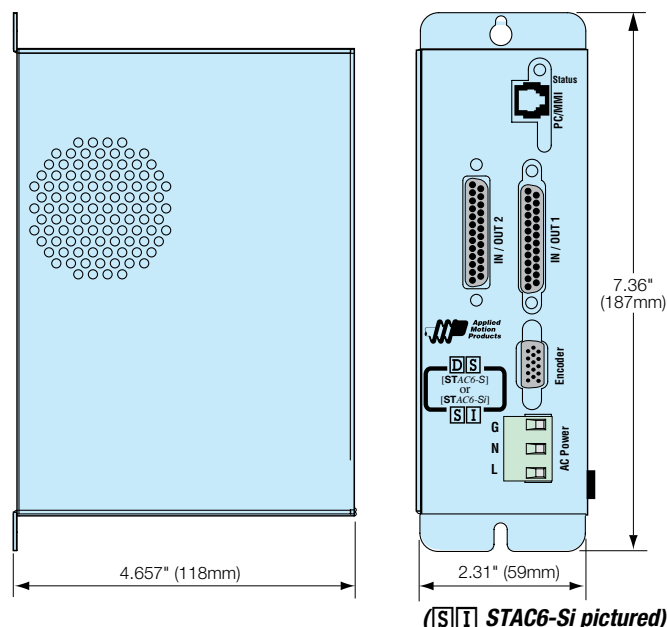

**[SI]** STAC6-Si pictured

**▲ Please note the Tolomatic ordering codes. Use these codes when ordering stepper components from Tolomatic (Applied Motion Products model equivalents appear in [brackets])**

# Stepper Products

## CONFIGURATOR™ & SI PROGRAMMER™ SOFTWARE

### Set-up and Configuration Software

The A.M.P. [Applied Motion Products] **CONFIGURATOR™** software simplifies the setup and configuration of the **DS** [STAC6-S] & **SI** [STAC6-Si]. Click on the icon representing the aspect of the drive that needs changing and an intuitive dialog box will open. Configuration data for A.M.P. recommended motors is available from a drop down menu.



Input / Output Monitor screen capture

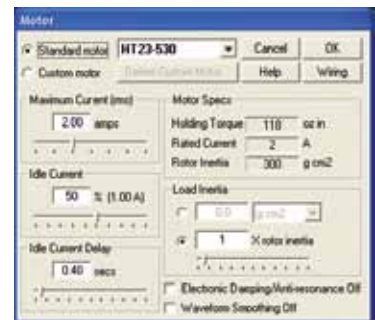

Motor selection screen capture

### SI PROGRAMMER™ SOFTWARE

The **SI** [STAC6-Si] is designed to be both configured and programmed through software. Virtually all the **SI**'s [STAC6-Si] functions are controlled by software. The *Si Programmer™* software that comes with the drive allows setting the motor current, the step resolution, jogging parameters and limit switch polarity. It also allows the writing of complex motion control and machine interaction programs.



Instruction/Tool menu

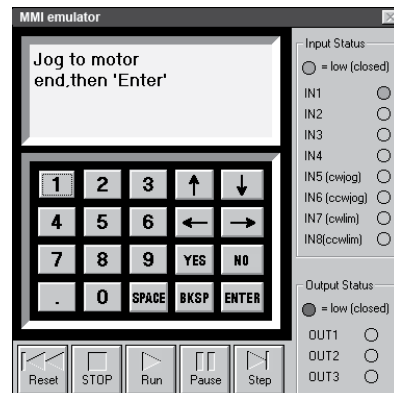

On screen MMI emulation

# Stepper Products

## MRS2 23-FRAME STEP MOTORS

### SPECIFICATIONS

ORDER CODE	A.M.P. MODEL	HOLDING TORQUE oz-in	RATED CURRENT A	RESISTANCE Ohms	INDUCTANCE mH	ROTOR INERTIA oz-in <sup>2</sup>
MRS21	[HT23-548D]	60	1.5	3.4	6	.65
MRS22	[HT23-549D]	118	1.4	4.2	12.8	1.64
MRS23	[HT23-550D]	181	2.9	5.1	15.2	2.62

Ratings are with motor connected in series

### TORQUE CURVES

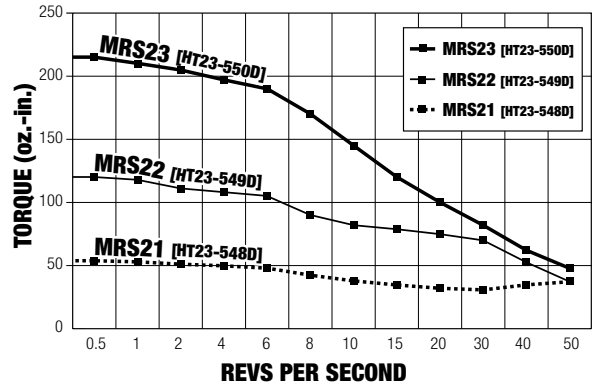

### DIMENSIONS

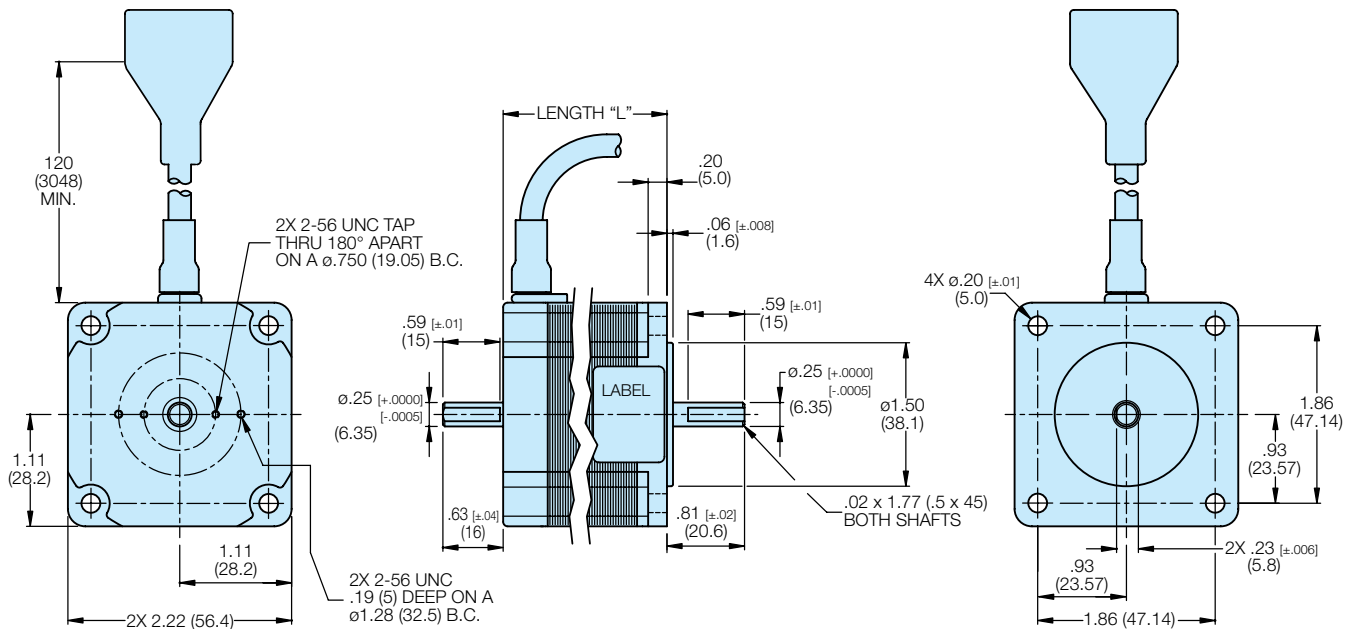

ORDER CODE	A.M.P. MODEL	LENGTH "L"	
		in.	mm
MRS21	[HT23-548D]	1.71	43.4
MRS22	[HT23-549D]	2.19	55.6
MRS23	[HT23-550D]	3.05	77.5

**▲ Please note the Tolomatic ordering codes. Use these codes when ordering stepper components from Tolomatic**  
 (Applied Motion Products model equivalents appear in [brackets])

# Stepper Products

## MRS3 34-FRAME STEP MOTORS

### SPECIFICATIONS

ORDER CODE	A.M.P. MODEL	HOLDING TORQUE oz-in	RATED CURRENT A	RESISTANCE Ohms	INDUCTANCE mH	ROTOR INERTIA oz-in <sup>2</sup>
MRS31	[HT34-488D]	650	5.1	1.6	5.2	7.8
MRS32	[HT34-489D]	1200	5.1	1.7	.88	14.6
MRS33	[HT34-490D]	1845	5.8	1.7	.96	21.9

Ratings are with motor connected in series

### TORQUE CURVES

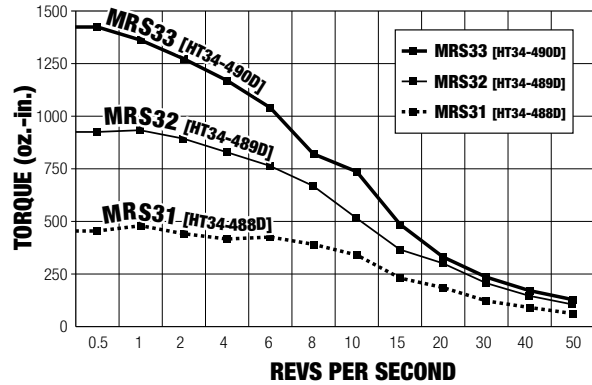

### DIMENSIONS

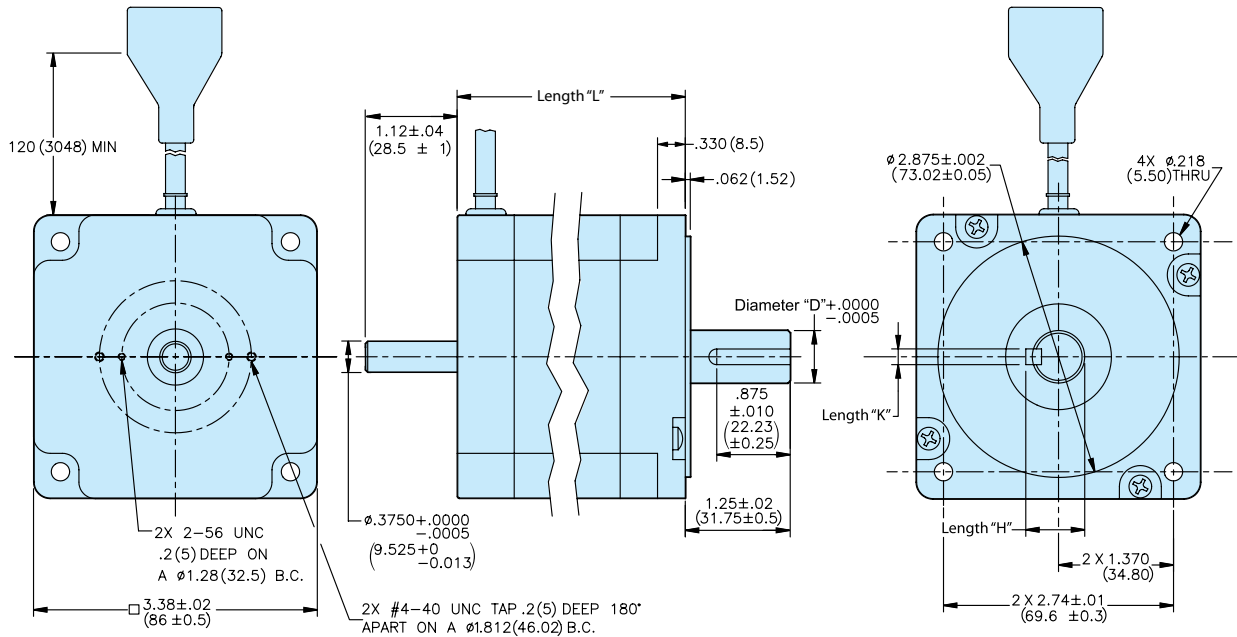

ORDER CODE	A.M.P. MODEL	DIA. "D"		LENGTH "H"		LENGTH "K"		LENGTH "L"	
		in.	mm	in.	mm	in.	mm	in.	mm
MRS31	[HT34-488D]	.5	12.7	.556	14.12	.125	3.18	3.11	79.0
MRS32	[HT34-489D]	.5	12.7	.556	14.12	.125	3.18	4.63	117.6
MRS33	[HT34-490D]	.625	15.88	.705	17.91	.1875	4.763	6.14	155.9



# Stepper Products

## **HUB** MULTI-AXIS MOTION HUB WITH I/O



### **DESCRIPTION**

The **HUB** [SiNet Hub444] allows up to 4 stepper drives to be controlled in host mode from a single PC, a PLC's RS-232 serial port, or run in stand-alone mode. Each indexer-drive acquires its address from the port to which it is connected. This simple addressing scheme minimizes drive set-up and configuration time. Connections are made with low-cost, reliable (RJ11) telephone cabling.

The **HUB** [SiNet Hub444] is powered by the drive that is connected to port #1, saving you the cost and installation expense of using a separate power supply. Si™ Command Language (SCL) allows a host PC or PLC to execute relative, absolute and homing moves, make status inquiries, sample inputs, set outputs, and more.

### **FEATURES:**

- Networks stepper products for multi-axis motion applications
- For real-time execution of commands downloaded from a host PC or PLC using Si™ Command Language (SCL)
- Programmable for stand-alone single or multi-axis operations with Applied Motion's easy to use *SiNet Hub Programmer™* Windows software (software and programming cable included)
- Communication via RS232
- Four optically-isolated programmable inputs
- Four optically-isolated programmable outputs
- DIN rail mounting

SiNet Programmer Windows® software allows the user to create and store multi-axis motion control programs in the **HUB** [SiNet Hub444] and run them without a PC. This function allows the user to create a multi-axis motion system controlled from an operator interface or trigger.

If your application requires multiple axes to operate in "host mode" you can connect any programmable drive directly to your PC via the **HUB** [SiNet Hub444] and invoke the Si™ Command Language (SCL).

# Stepper Products

## **HUB** MULTI-AXIS MOTION HUB WITH I/O

### TECHNICAL SPECIFICATIONS

Power	Power is provided by Si indexer-drive on Port 1. Provides up to 50 mA for MMI via PC/MMI port
Communication	Ports 1 - 4: RS232, 9600 bps, 8 data bits, one stop bit, no parity MMI: same PC in router mode: same PC when running <i>SiNet Hub Programmer™</i> software: 19200 bps Max cable length, any port: 50 feet
Physical	Constructed on .062" fiberglass printed circuit board with 4 .156" mounting holes (nylon spacers included). 4.2" x 2.85" x 0.72" Two red LEDs Operating temperature range: 0 - 70° C DIN rail mounting (fits ENS0022 35 mm rail)
Program	Move distances: +/- 16,000,000 steps Move speeds: .025 to 50 rev/sec Accel/Decel range: 1 to 3000 rev/sec/sec Time delays: .01 to 300 seconds Loop counts: 1 to 65,535 Number of nested loops: unlimited Number of subroutines: unlimited Subroutine stack depth: 5 calls maximum Number of comments: limited only by 200 line program length MMI variables for storing speeds, distances and loop counts entered by operator: 50 Maximum size of messages displayed by an MMI Prompt: 60 characters (80 for an MMI Menu instruction) Maximum total size of all MMI Prompt messages: 1500 characters Steps/revolution: 2,000 - 50,800
Connectors	RJ11 for drives and PC/MMI. Screw terminals for programmable inputs and outputs. Accept AWG 16-28 wire
Programmable Inputs	Optically isolated, 2200 ohms internal impedance, 5-24 VDC.
Programmable Outputs	Optically isolated (photo darlington), 28 VDC max, 100 mA max.

### DIMENSIONS

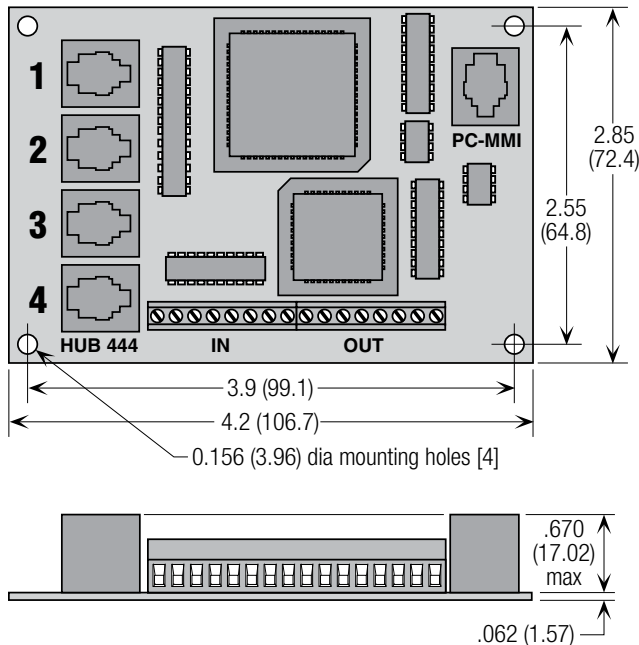

### BLOCK DIAGRAM

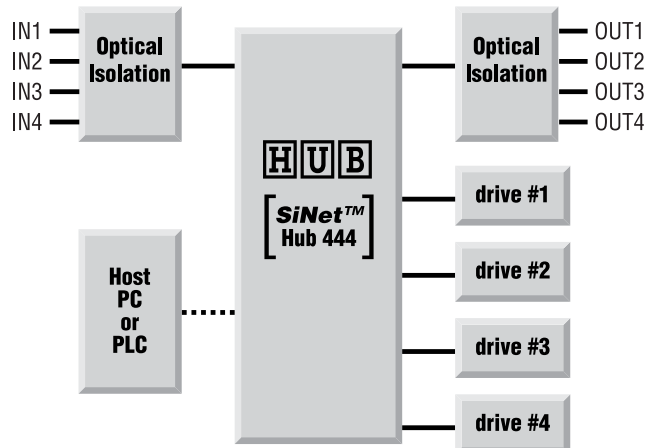

# Stepper Products

## **M M I** OPERATOR INTERFACE

User interaction with the **S I** [STAC6-Si] is simple with the **M M I** operator interface. Software allows visual setup of the panel to show a particular action taking place, it prompts the user to make a decision, or provides information such as move distance, move speed, repeat count.

### FEATURES

- Flush or surface mounting
- Four line by 20 character LCD display
- Uses (RJ11) telephone cable with **S I** [STAC6-Si] controllers
- Enter distances, speeds and repeat counts to pre-assigned variables in **S I** [STAC6-Si].

### CABLES

Motor cable and encoder cable are included when ordering **S I** [STAC6-Si] controllers. User supplies (RJ11) telephone cables.



### DIMENSIONS

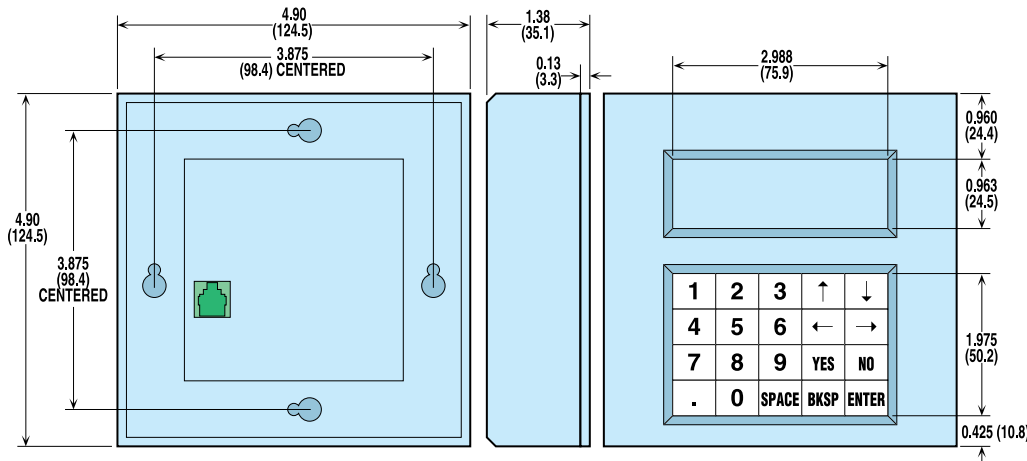

Unless otherwise noted, all dimensions shown are in inches (Dimensions in parenthesis are in millimeters)

## **B O B** BREAK OUT BOARD



Break Out Boards **B O B** for the DB25 I/O connectors of a **D S** [STAC6-S] & **S I** [STAC6-Si] drive are available. Each Break out board comes with a 1 foot extension cable and a din-rail mountable terminal strip to make connecting the I/O points of a **D S** [STAC6-S] & **S I** [STAC6-Si] drive easier.

**B O B 1** is for the IN/OUT1 connector of **D S** [STAC6-S] & **S I** [STAC6-Si] drives.

**B O B 2** is for the IN/OUT2 connector of **S I** [STAC6-Si] drive only.

**▲ Please note the Tolomatic ordering codes. Use these codes when ordering stepper components from Tolomatic (Applied Motion Products model equivalents appear in [brackets])**

# Stepper Products

## ORDERING

After the ordering codes for the Tolomatic actuator have been entered, the ordering codes for the stepper products will follow.

**MRS 23 SI ENC GHS205 HUB MMI BOB1 BOB2**

MOTOR TYPE	
ORDER	DESCRIPTION
<b>MRS</b>	Stepper Motor

ENCODER	
<b>ENC</b>	Encoder (converts rotary motion to code of electronic pulses); 10ft. (3m) cable

MOTOR SIZE / DRIVE SIZE			
ORDER CODE	A.M.P. MODEL	FRAME SIZE	STACK SIZE
<b>21</b>	[HT23-548D]	23	1
<b>22</b>	[HT23-549D]	23	2
<b>23</b>	[HT23-550D]	23	3
<b>31</b>	[HT34-488D]	34	1
<b>32</b>	[HT34-489D]	34	2
<b>33</b>	[HT34-490D]	34	3

PLANETARY GEARBOX REDUCTIONS*					
[For <b>IMI</b> (Screw-drive inline) or <b>SDL</b> & <b>SDR</b> (Belt-drive direct-drive) mounting only]					
ORDER CODE	[APEX] MODEL	INPUT DIA.	MOTOR FRAME SIZE	REDUCTION RATIO	
<b>GHS205</b>	AN23	1/4-inch	23	5 : 1	
<b>GHS210</b>	AN23	1/4-inch	23	10 : 1	
<b>GHS305</b>	AN34	1/2-inch	34	5 : 1	
<b>GHS310</b>	AN34	1/2-inch	34	10 : 1	

\*See Tolomatic Planetary Gearbox publication #3600-4161 or www.tolomatic.com for complete information

Once motor type and frame size is selected, the appropriate adapter and couplers required are automatically chosen for assembly onto actuator.

### SPECIFY ONE OF THESE FIVE CODES DRIVE CHOICE

**DS** Stepper Drive [STAC6-S] order **BOB1** for cables

**SI** Controller/Stepper Drive [STAC6-Si] order **BOB1** & **BOB2** for cables

**MI** Motor Only

### CUSTOMER MOTOR OPTIONS

**XY**\* Customer supplied motor(s) shipped to Tolomatic for mounting. Tolomatic to mount using standard hardware and couplers

**XJ**\* Motor(s) supplied and mounted by customer, Tolomatic to furnish standard hardware and couplers

\* For **XY** and **XJ** options, a full endface and shaft dimensional drawing must accompany the order for the actuator. Customer motors must be directly interchangeable with Tolomatic motors.

MULTI-AXIS APPLICATIONS	
ORDER	DESCRIPTION
<b>HUB</b>	Multi-Axis Motion Hub with I/O [SiNet Hub 444] (RJ11) telephone cables included

USER INTERFACE	
<b>MI</b>	Operator interface (for use with <b>SI</b> )

BREAK OUT BOARD	
<b>BOB1</b>	Break out board & cable (for use with <b>DS</b> & <b>SI</b> )
<b>BOB2</b>	Break out board & cable (for use with <b>SI</b> ) NOTE: for <b>SI</b> it is recommended to order <b>BOB1</b> also.



Not all codes listed are compatible with all options

Use the Tolomatic sizing and selection software to determine available options and accessories based on your application requirements

User manuals and software CD-ROM is included with any controller or drive ordered. Manuals and software are also available for download at www.tolomatic.com

Consult Tolomatic to select or purchase individual components, not part of a system

## PART NUMBERS

ORDER CODE	PART NO.	A.M.P. MODEL	DESC.
MRS21	3604-1600	[HT23-548D]	Motor
MRS22	3604-1601	[HT23-549D]	Motor
MRS23	3604-1602	[HT23-550D]	Motor
MRS31	3604-1603	[HT34-488D]	Motor
MRS32	3604-1604	[HT34-489D]	Motor

ORDER CODE	PART NO.	A.M.P. MODEL	DESC.
MRS33	3604-1605	[HT34-490D]	Motor
DS	3604-0030	[Stac6-S]	Drive
SI	3604-0031	[Stac6-Si]	Drive/Controller
ENC	3604-1606	-	23 Frame Encoder
ENC	3604-1607	-	34 Frame Encoder

ORDER CODE	PART NO.	A.M.P. MODEL	DESC.
-	3604-1608	-	Encoder Cable
HUB	3604-1612	[SiNet Hub444]	Multi-Axis Hub
BOB1	3604-1609	-	Breakout Block DS/SI
BOB2	3604-1610	-	Breakout Block SI
	3604-1611	-	Breakout Cable